

USER GUIDE

Solar Inverter

GPEO Series(4KVA/6KVA/12KVA)

Solar Inverter



Contents

ABOUT THIS MANUAL	01
Purpose	01
Scope	01
Safety instructions	01
WARNING MARKS	02
INTRODUCTION	03
Features	03
Basic system architecture	03
PRODUCT OVERVIEW	04
SPECIFICATIONS	06
INSTALLATION	09
Safety guidance	09
Unpacking and inspection	09
Preparation	10
Mounting the unit	10
Battery connection	11
AC input/output connection	12
PV connection	14
Dry contact signal	16
Wiring System for Inverter	17
OPERATION	19
Power on/off	19
Operation and display panel	19
LCD display icons	20
LCD operation flow chart	22
Base information page	22
Setting page	25
Energy stored data page	32
BMS information page	32
Rated information page	33
Lithium battery communication	34
PARALLEL INSTALLATION GUIDE	35
Introduction	35
Mounting the unit	35
Package contents	36
Wiring connection	36
LCD setting and display	44
Commissioning	44
WARNING CODE TABLE	46
FAULT CODE TABLE	46

ABOUT THIS MANUAL

Purpose

This manual describes the assembly, installation, operation, warning code and fault code of this unit. Please read this manual carefully before installations and operations. Keep this manual for future reference.

Scope

This manual provides safety and installation guidelines as well as information on tools and wiring.









Safety Instructions

 **WARNING: This chapter contains important safety and operating instructions. Read and keep this manual for future reference.**

1. Before using the unit, read all instructions and cautionary markings on the unit, the batteries and all appropriate sections of this manual.
2. **CAUTION** To reduce risk of injury, charge only deep-cycle lead acid type rechargeable batteries. Other types of batteries may burst, causing personal injury and damage.
3. Do not disassemble the unit. Take it to a qualified service center when service or repair is required. Incorrect re-assembly may result in a risk of electric shock or fire.
4. To reduce risk of electric shock, disconnect all wirings before attempting any maintenance or cleaning. Turning off the unit will not reduce this risk.
5. **CAUTION** Only qualified personnel can install this device with battery.
6. **NEVER** charge a frozen battery.
7. For optimum operation of this inverter/charger, please follow required spec to select appropriate cable size. It's very important to correctly operate this inverter/charger.
8. Be very cautious when working with metal tools on or around batteries. A potential risk exists to drop a tool to spark or short circuit batteries or other electrical parts and could cause an explosion.
9. Please strictly follow installation procedure when you want to disconnect AC or DC terminals. Please refer to INSTALLATION section of this manual for the details.
10. Fuse is provided as over-current protection for the battery supply.
11. **GROUNDING INSTRUCTIONS** This inverter/charger should be connected to a permanent grounded wiring system. Be sure to comply with local requirements and regulation to install this inverter.
12. **NEVER** cause AC output and DC input short circuited. Do NOT connect to the mains when DC input short circuits.
13. **WARNING!!** Only qualified service persons are able to service this device. If errors still persist after following troubleshooting table, please send this inverter/charger back to local dealer or service center for maintenance.
14. **WARNING!!** This series of off-grid inverters provides a backfeed function without grid-tie protection. If enabled, implement protective measures prior to operation. The customer assumes full liability for any accidents resulting from the use of this function.

WARNING MARKS

Warning marks inform users of conditions which can cause serious physical injury or death, or damage to the device. They also tell users how to prevent the dangers. The warning marks used in this operation manual are shown below:

Mark	Name	Instruction	Abbreviation	
	Danger	Danger	Serious physical injury or even death may occur if not follow relevant requirements.	
	Warning	Warning	Physical injury or damage to the device may occur if not follow relevant requirements.	
	Forbid	Electrostatic sensitive	Damage may occur if relevant requirements are not followed.	
	Hot	High temperature	Do not touch the base of the inverter as it will become hot.	
	Note	Note	The procedures taken for ensuring proper operation.	Note

INTRODUCTION

This is a multi-function inverter/charger, combining functions of inverter, MPPT solar charger and battery charger to offer uninterruptible power support with portable size. Its comprehensive LCD display offers user-configurable and easy-accessible button operation such as battery charging current, AC/solar charger priority, and acceptable input voltage based on different applications.

Features

- Pure sine wave inverter
- Built-in MPPT solar charge controller
- Configurable input voltage range for home appliances and personal computers via LCD setting
- Configurable battery charging current based on applications via LCD setting
- Configurable AC/Solar Charger priority via LCD setting
- Compatible to mains voltage or generator power
- Auto restart while AC is recovering
- Overload / Over temperature / short circuit protection
- Inverter running without battery
- Lithium battery activation function
- Cold start function
- Parallel connection quantity up to 12 units for 6KVA and 12KVA model (Battery must be connected)
- Intelligent fan control greatly reduces fan noise

Basic System Architecture

The following illustration shows basic application for this inverter/charger. It also includes following devices to have a complete running system:

- Generator or Utility
- PV modules (option)

Consult with your system integrator for other possible system architectures depending on your requirements.

This inverter can power all kinds of appliances in home or office environment, including motor-type appliances such as tube light, fan, refrigerator and air conditioner.

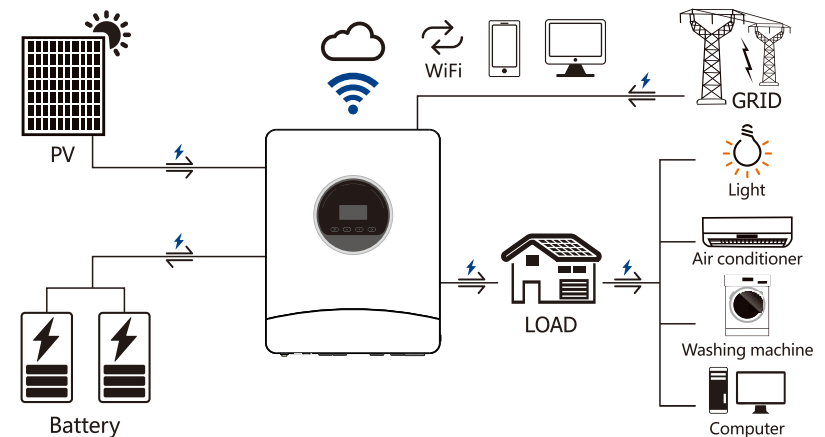

PRODUCT OVERVIEW

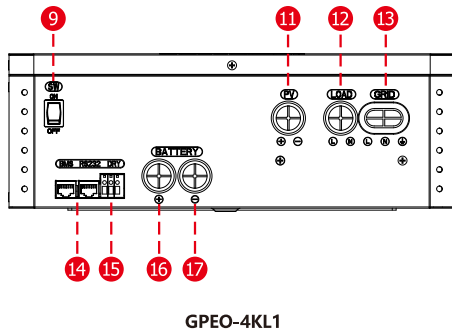
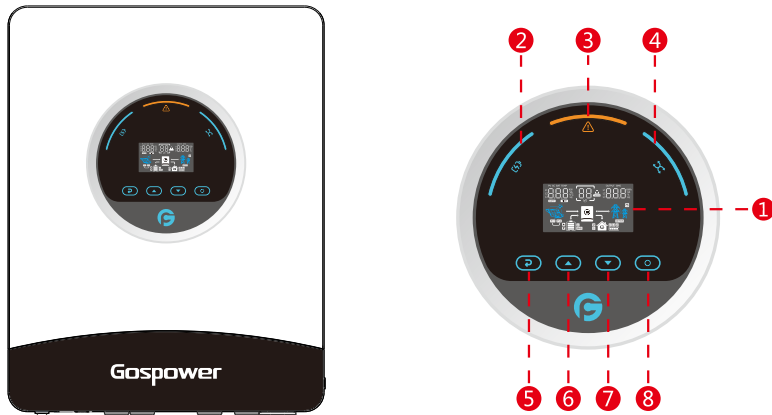

GPEO-4KL1

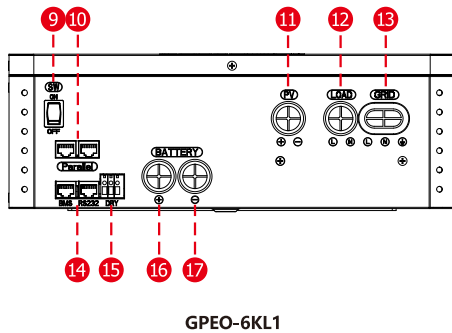

GPEO-6KL1

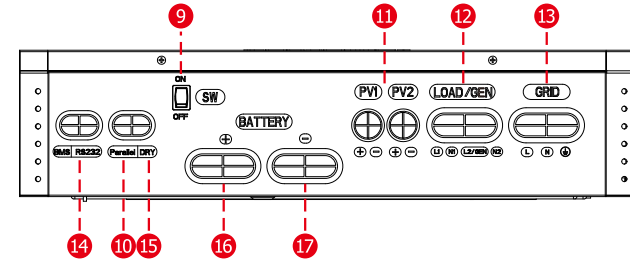

GPEO-12KL1

- 1. LCD display
- 2. Charging indicator
- 3. Fault or warning indicator
- 4. Utility bypass/Inverter indicator
- 5. ESC button
- 6. UP button
- 7. Down button
- 8. Enter button
- 9. Switch
- 10. Parallel connection-CAN port
- 11. PV input connection port
- 12. AC output/Generator port
- 13. AC input port
- 14. Communication connection port
- 15. Dry contact port
- 16. Battery+ connection port
- 17. Battery- connection port

14 Definition of BMS communication port pin

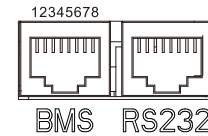

NO.	BMS(4KVA/6KVA)	BMS(12KVA)	RS-232
1	NC	RS485-B	RS232-TXD
2	NC	RS485-A	RS232-RXD
3	NC	VSS	VDD
4	NC	NC	VSS
5	NC	NC	NC
6	VSS	VSS	NC
7	RS485-A	RS485-A	NC
8	RS485-B	RS485-B	VSS

SPECIFICATIONS

Line Mode Specifications			
Model	GPEO-4KL1	GPEO-6KL1	GPEO-12KL1
Rated Output Power	4000VA	6000VA	12000VA
	4000W	6000W	12000W
Nominal DC Input Voltage	24V	48V	48V
Input Voltage Waveform	Sinusoidal (utility or generator)		
Nominal Input Voltage	230Vac		
Low Line Voltage Disconnect	90Vac±3V(For Home Appliances: APL)170Vac±3V(For Computers: UPS)		
Low Loss Voltage Re-connect	100Vac±3V(For Home Appliances: APL)180Vac±3V(For Computers: UPS)		
High Line Voltage Disconnect	280Vac±3V		
High Line Voltage Re-connect	270Vac±3V		
Max AC Input Voltage	280Vac±3V		
Nominal Input Frequency	50Hz/60Hz(Auto detection)		
Low Line Frequency Disconnect	40±1Hz		
Low Line Frequency Re-connect	42±1Hz		
High Line Frequency Disconnect	65±1Hz		
High Line Frequency Re-connect	63±1Hz		
Output Voltage Waveform	As same as input waveform		
Output Short Circuit Protection	Line mode: Circuit Breaker; Battery mode: Electronic Circuits		
Efficiency (Line Mode)	>95%(Rated R load, battery full charged)		
Transfer Time (Single unit)	10ms typical (UPS); 20ms typical (Appliances)		
Transfer Time (Parallel)	50ms typical		
Pass Through Without Battery	Yes		
Max. Bypass Overload Current	28A	40A	70A
Max. Bypass Input Current	28A	50A	90A
Max. Inverter/Rectifier Current	18.2A/4000W	27.3A/6000W	54.5A/12000W

Utility Charge Mode Specifications			
Model	GPEO-4KL1	GPEO-6KL1	GPEO-12KL1
Nominal Input Voltage	230Vac		
Input Voltage Range	90-280Vac		
Nominal Output Voltage	Dependent on battery type		
Max. Grid Charge Current	100A	120A	210A
Charge Current Regulation	10A-Max. Grid Charge Current (Adjustable unit is 1A)		
Over Charge Protection	Yes		
Grid charging Current (I.max/I.min)	100A/25A	120A/30A	210A/50A
Relationship between battery charging current and grid voltage.			
Solar Charging & Grid Charging			
Max. PV Open Circuit Voltage	500V		
PV voltage range	85V-450V		
Max. Input Power	6000W	8000W	16000W
Max. Solar Charging Current	120A	120A	210A
Max. Charging Current(PV+Grid)	120A	120A	210A
Max.PV Input Current	15A	27A	27A+27A
Min. Startup Voltage	80V	75V	75V
Charge Algorithm			
Algorithm	Three stage: Boost CC (Constant current stage)-> Boost CV(Constant voltage stage)-> Float FV(Constant voltage stage)		
Charging Curve			
Battery Type Setting	Battery Type	Boost CC/CV	Float
	AGM	28.2V/56.4V	27V/54V
	Flooded	29.2V/58.4V	27V/54V
	Self-defined Lithium	Adjustable, up to 30V/60V	

Inverter Mode Specifications			
Model	GPEO-4KL1	GPEO-6KL1	GPEO-12KL1
Rated Output Power	4000VA	6000VA	12000VA
	4000W	6000W	12000W
Nominal DC Input Voltage	24V	48V	48V
DC Max.charging/Discharging current	120A/160A	120A/125A	210A/230A
Output Voltage Waveform	Pure sine wave		
Nominal Output Voltage	230Vac±3%		
Nominal Output Frequency(Hz)	50±0.2Hz/60±0.2Hz(Adjustable)		
Parallel capability	No	Yes, up to 12 units	
Peak Efficiency	93%		
Over-Load Protection(SMPS load)	5s@≥150%load; 10s@105%~150%load		
Surge Rating	2* rated power for 5s		
Capable of Starting Electric	Yes		
Output Short Circuit Protection	Yes		
Cold Start Voltage	23V	46V	
Low DC Input Shut-down Load < 50%/@Load ≥ 50%	21.5V/21V	43V/42V	
High DC Input Alarm & Fault	31V±0.2V	62V±0.4V	
High DC Input Recovery	29V±0.2V	60V±0.4V	
Battery Voltage Limitation (V.bat0/V.bat1/V.bat2)	21V/27.2V/31V	42V/50V/62V	
When battery voltage is lower than "V.bat1", output power will be derated. The minimum AC output voltage is 180V.			
Temperature Limitation(Td)	40°C	45°C	45°C
When ambient temperature is higher than 40°C/45°C, output power will be derated. The minimum Ac output voltage is 180V.			
General Specifications			
Operating Temperature	-10°C~55°C		
Range Storage Temperature	-15°C~60°C		
Net Weight(kg)	9.2kg	13kg	27kg
Gross Weight(kg)	11.4kg	15kg	30kg
Product Size(D*W*H)	347x445x120mm		525x630x125mm
Package Dimension(D*W*H)	560x465x240mm		715x620x210mm

INSTALLATION

Safety Guidance

Warning marks inform users of conditions which can cause serious physical injury or death, or damage to the device. They also tell users how to prevent the dangers. The warning marks used in this operation manual are shown below:

	<ul style="list-style-type: none"> After receiving this product, first confirm the product package is intact. If any question, contact the logistic company or local distributor immediately. The installation and operation of inverter must be carried out by professional technicians who have received professional trainings and thoroughly familiar with all the contents in this manual and the safety requirements of the electrical system.
	<ul style="list-style-type: none"> Do not carry out connection/disconnection, unpacking inspection and unit replacement operations on the inverter when power source is applied. Before wiring and inspection, users must confirm the breakers on DC and AC side of inverter are disconnected and wait for at least 5 minutes.
	<ul style="list-style-type: none"> Ensure there is no strong electromagnetic interference caused by other electronic or electrical devices around the installation site. Do not refit the inverter unless authorized. All the electrical installation must conform to local and national electrical standards.
	<ul style="list-style-type: none"> Do not touch the housing of the inverter or the radiator to avoid scald as they may become hot during operation.
	<ul style="list-style-type: none"> Ground with proper technics before operation.
	<ul style="list-style-type: none"> Do not open the surface cover of the inverter unless authorized. The electronic components inside the inverter are electrostatic sensitive. Do take proper anti-electrostatic measures during authorized operation.
	<ul style="list-style-type: none"> The inverter needs to be reliably grounded.
	<ul style="list-style-type: none"> Ensure that DC and AC side circuit breakers have been disconnected and wait at least 5 minutes before wiring and checking.

Unpacking and Inspection

Before installation, please inspect the unit. Be sure that nothing inside the package is damaged. You should have received the following items inside of package:

Inverter unit x 1	Manual x 1	Parallel communication cable and connector x 1 ^{1*}	WiFi extension Cable x 1 ^{2*}	O-shaped terminal M5 x 4 and M6 x 3 ^{2*}
O-shaped terminal RNB38-6 M6 ^{3*}	Battery input screw ^{3*}	Case grounding screw x 1	Expansion bolt x 3	Wall Hangers x 1 and Screws x 3

1* : Only for 6KVA and 12KVA

2* : Only for 12KVA

3* : 2pcs for 4KVA/6KVA, 4pcs for 12KVA

Preparation

Before connecting all wirings, please take off bottom cover by removing three or four screws as shown below.

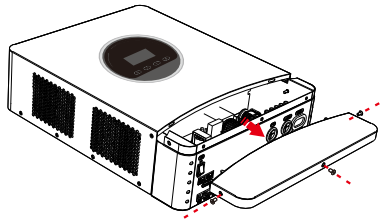

GPEO-4KL1/GPEO-6KL1

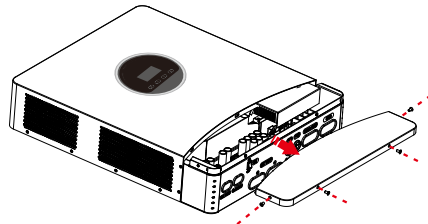

GPEO-12KL1

Mounting the Unit

Consider the following points before selecting where to install:

- Do not mount the inverter on flammable construction materials.
- Mount on a solid surface.
- Install this inverter at eye level in order to allow the LCD display to be read at all times.
- The ambient temperature should be between -10°C and 55°C to ensure optimal operation.
- The recommended installation position is to be adhered to the wall vertically.
- Be sure to keep other objects and surfaces as shown in the right diagram to guarantee sufficient heat dissipation and to have enough space for removing wires.

Installation Steps:

1. Install the bracket with M4 screw to connect the bracket with the inverter;
2. Then install the inverter on the wall with M3 expansion screw, and leave a distance of 60cm between the inverters, as shown in the figure:

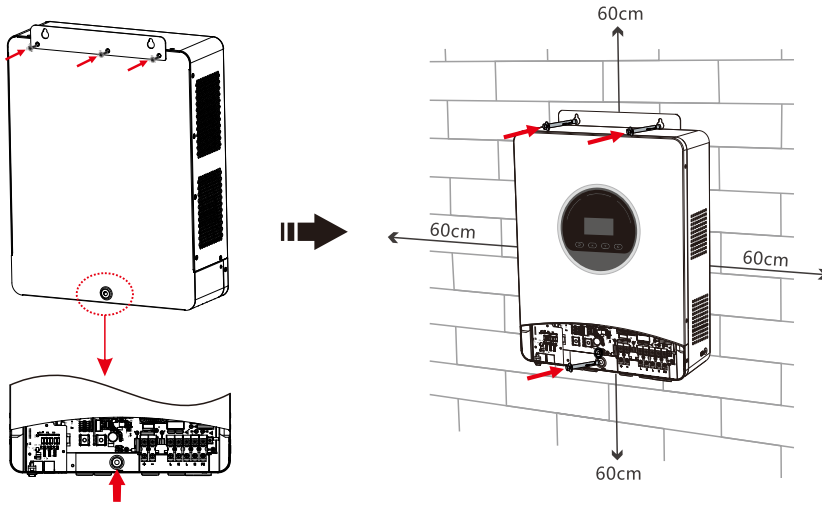

SUITABLE FOR MOUNTING ON CONCRETE OR OTHER NON-COMBUSTIBLE SURFACE ONLY.

Battery Connection

CAUTION: For safety operation and regulation compliance, it's requested to install a separate DC over-current protector or disconnect device between battery and inverter. It may not be requested to have a disconnect device in some applications, however, it's still requested to have over-current protection installed. Please refer to typical amperage in below table as required fuse or breaker size.

WARNING! All wiring must be performed by a qualified personnel.

WARNING! It's very important for system safety and efficient operation to use appropriate cable for battery connection. To reduce risk of injury, please use the proper recommended cable and terminal size as below.

Recommended battery cable and terminal size:

Model	Wire Size	Cable(mm ²)	Torque Value(Max)
4KVA	1*1AWG	50	2 Nm
6KVA	1*2AWG	35	2 Nm
12KVA	2*2AWG	35	2 Nm

Please follow below steps to implement battery connection:

1. Assemble battery ring terminal based on recommended battery cable and terminal size.
2. Connect all battery packs as units requires. It's suggested to connect at least 200Ah capacity battery.
3. Insert the ring terminal of battery cable flatly into battery connector of inverter and make sure the bolts are tightened with torque of 2 Nm. Make sure polarity at both the battery and the inverter/charge is correctly connected and ring terminals are tightly screwed to the battery terminals.

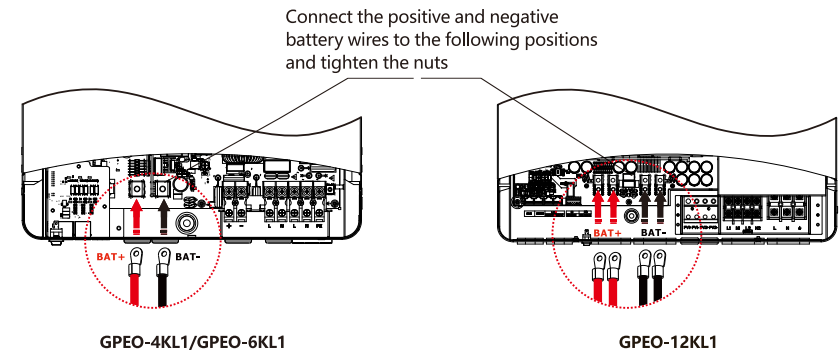

WARNING: Shock Hazard

Installation must be performed with care due to high battery voltage in series.



CAUTION!! Do not place anything between the flat part of the inverter terminal and the ring terminal. Otherwise, overheating may occur.

CAUTION!! Do not apply anti-oxidant substance on the terminals before terminals are connected tightly.

CAUTION!! Before making the final DC connection or closing DC breaker/disconnector, be sure positive (+) must be connected to positive (+) and negative (-) must be connected to negative (-).

AC Input/Output Connection

CAUTION!! Before connecting to AC input power source, please install a separate AC breaker between inverter and AC input power source. This will ensure the inverter can be securely disconnected during maintenance and fully protected from over current of AC input. The recommended spec of AC breaker is 28A for 4kVA/ 50A for 6kVA/ 100A for 12kVA.

CAUTION!! There are two terminal blocks with "IN" and "OUT" markings. Please do NOT mis-connect input and output connectors.
WARNING! All wiring must be performed by qualified personnel.
WARNING! It's very important for system safety and efficient operation to use appropriate cable for AC input connection. To reduce risk of injury, please use the proper recommended cable size as below.

Suggested cable requirement for AC wires:

Model	Gauge	Cable (mm ²)	Torque Value
4KVA	10AWG	6	1.2Nm
6KVA	8AWG	8	1.4~1.6 Nm
12KVA	4AWG	21	1.4~1.6 Nm

Recommended circuit breaker type for AC input:

Models	Maximum bypass	Recommended circuit breaker
4KVA	28A	2P-32A
6KVA	50A	2P-50A
12KVA	90A	2P-100A

Please follow below steps to implement AC input/output connection:

1. Before making AC input/output connection, be sure to open DC protector or disconnecter first.
2. Remove insulation sleeve 10mm for six conductors. And pressing ring terminal.

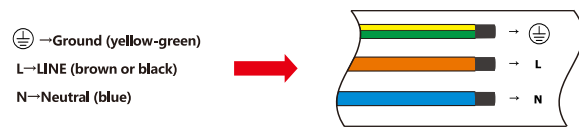

GPEO-4KL1/GPEO-6KL1



GPEO-12KL1

3*: ring terminal (M5 for AC output wires, M6 for AC input/PE wires)

3. Insert AC input wires according to polarities indicated on terminal block and tighten the terminal screws.
 Be sure to connect PE protective conductor (⊕) first.

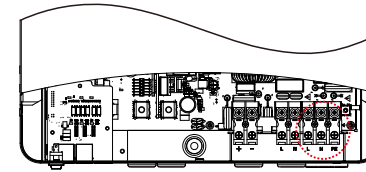

GPEO-4KL1/GPEO-6KL1

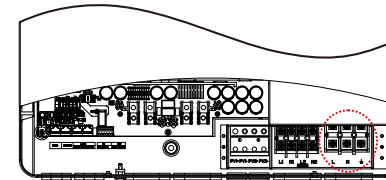
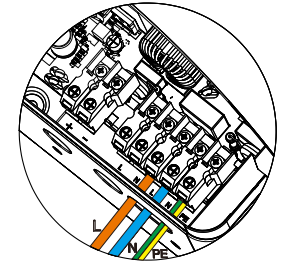

GPEO-12KL1

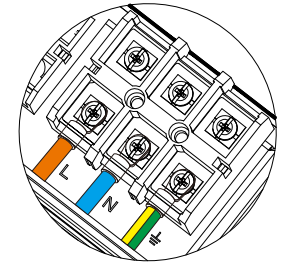

WARNING:
 Be sure that AC power source is disconnected before attempting to hardwire it to the unit.

4. Then, insert AC output/Generator input wires according to polarities indicated on terminal block and tighten terminal screws. Be sure to connect PE protective conductor (⊕) first.
 (Generator input function only For GPEO-12KL1)

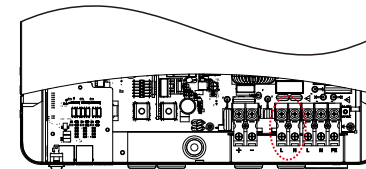

GPEO-4KL1/GPEO-6KL1

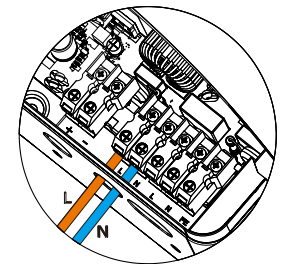

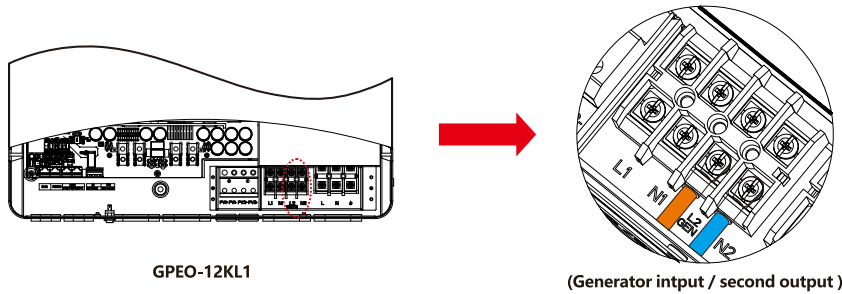
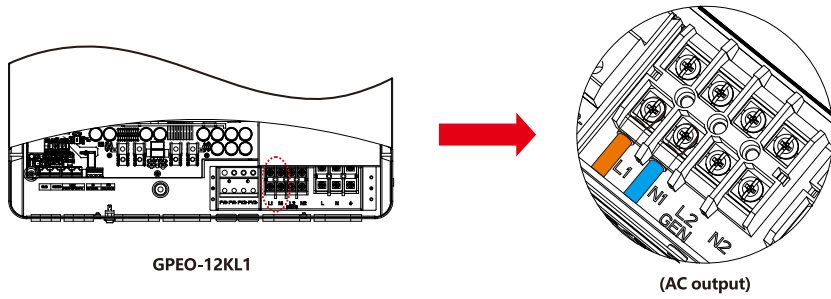

5. Make sure the wires are securely connected.

CAUTION: Important

Be sure to connect AC wires with correct polarity. If L and N wires are connected reversely, it may cause utility short-circuited when these inverters are worked in parallel operation.

CAUTION: Appliances such as air conditioner are required at least 2~3 minutes to restart because it's required to have enough time to balance refrigerant gas inside of circuits. If a power shortage occurs and recovers in a short time, it will cause damage to your connected appliances. To prevent this kind of damage, please check manufacturer of air conditioner if it's equipped with time-delay function before installation. Otherwise, this inverter/charger will trig overload fault and cut off output to protect your appliance but sometimes it still causes internal damage to the air conditioner.

PV Connection



CAUTION: Before connecting to PV modules, please install separately a DC circuit breaker between inverter and PV modules.

WARNING! All wiring must be performed by qualified personnel.

WARNING! It's very important for system safety and efficient operation to use appropriate cable for PV module connection. To reduce risk of injury, please use the proper recommended cable size as below.

Model	Cable Size	Cable (mm ²)	Torque
4KVA	10AWG	6	1.2Nm
6KVA	8AWG	8	1.2Nm
12KVA	8AWG	8	1.2Nm

PV Module Selection:

When selecting proper PV modules, please be sure to consider below parameters:

1. Open circuit Voltage (Voc) of PV modules not exceeds max. PV array open circuit voltage of inverter.
2. Max. power voltage (Vmp) should be during PV array MPPT voltage range.

Solar Charging Mode			
INVERTER MODEL	4KVA	6KVA	12KVA
Max. PV Array Open Circuit Voltage	500V		
PV Array MPPT Voltage Range	85Vdc~450Vdc		

Please follow below steps to implement PV module connection:

1. Remove insulation sleeve 10mm for positive and negative conductors.



2. Check correct polarity of connection cable from PV modules and PV input connectors. Then, connect positive pole (+) of connection cable to positive pole (+) of PV input connector. Connect negative pole (-) of connection cable to negative pole (-) of PV input connector.

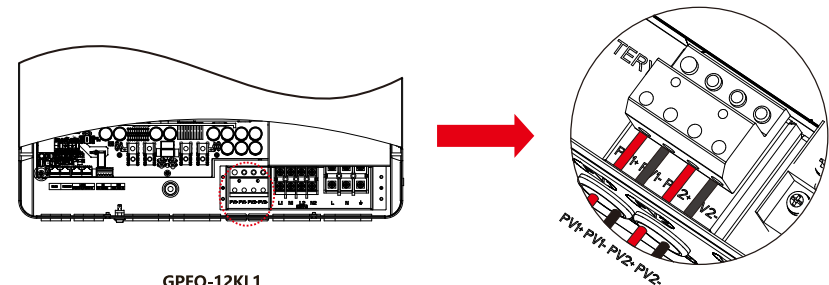
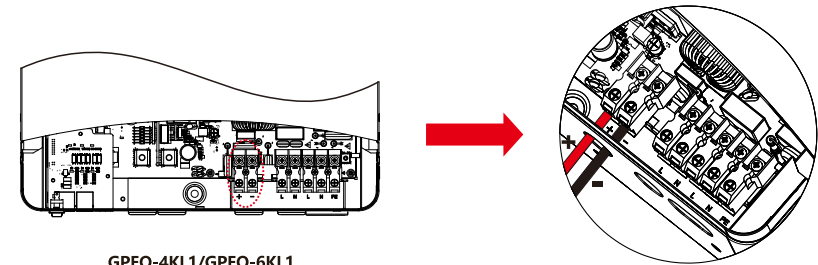

3. Make sure the wires are securely connected.

Dry Contact Signal

There is one dry contact (3A/250VAC) available on the inverter.

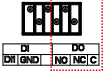
Unit Status	Condition	4KVA/6KVA		12KVA	
		Dry contact port:		Dry contact port:	
					
		NO & C	NC & C	NO & C	NC & C
Power Off	Unit is off and no output is powered.	Open	Close	Open	Close
Power On	Battery voltage < Setting value in Program 06	Close	Open	Close	Open
	Battery voltage > Setting value in Program 07 or battery charging reaches floating stage	Open	Close	Open	Close

Wiring System for Inverter

For GPEO-4KL1/GPEO-6KL1:

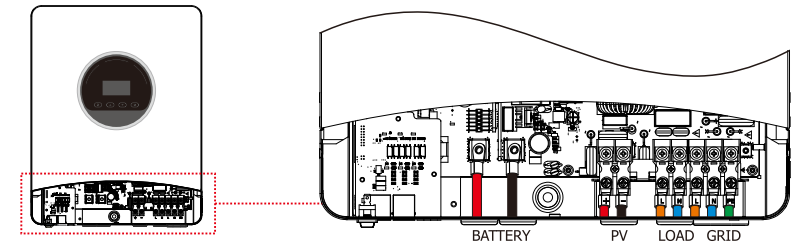

— BAT+ — BAT- — PV+ — PV- — L wrie — N wrie — PE wrie

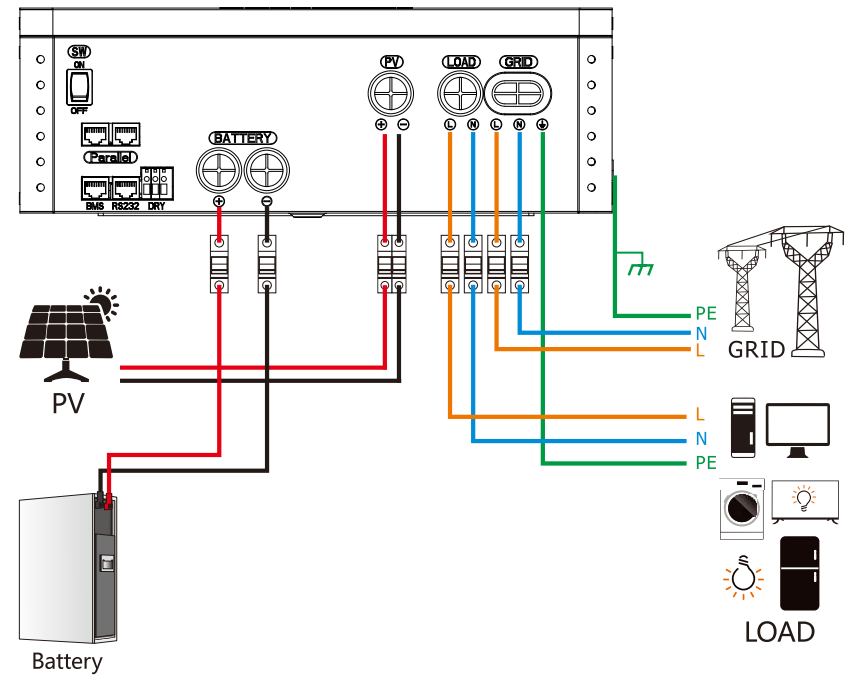

For GPEO-12KL1:

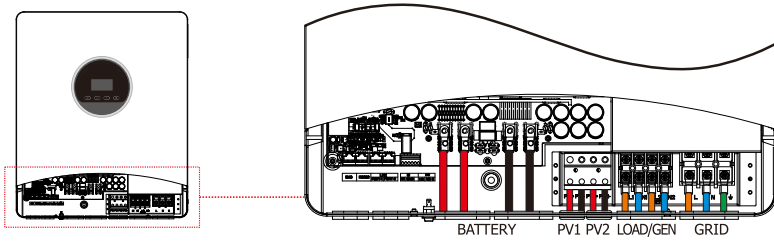

— BAT+ — BAT- — PV+ — PV- — L wire — N wire — PE wire

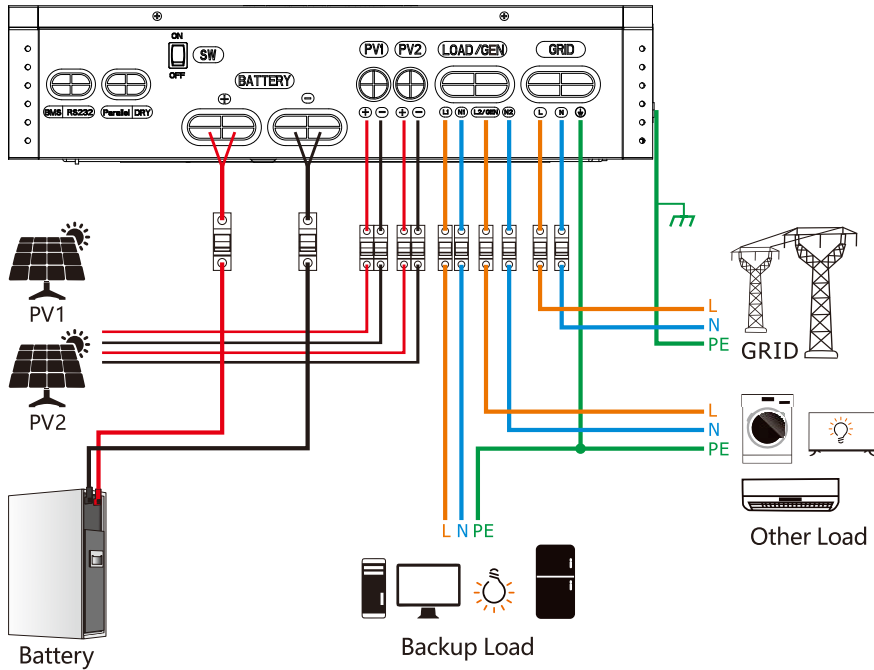

OPERATION

Power ON/OFF

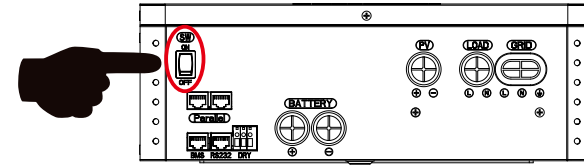

GPEO-4KL1/GPEO-6KL1

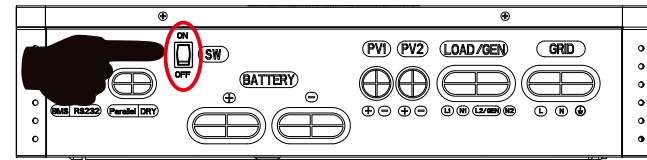

GPEO-12KL1

Once the unit has been properly installed and the batteries are connected well, simply press On/Off switch (located on the bottom of the case) to turn on the unit.

Operation and Display Panel

The operation and display panel, shown in below chart, is on the front panel of the inverter. It includes three indicators, four function keys and a LCD display, indicating the operating status and input/output power information.



Function Key	Icon	Description
ESC		To previous page
UP		To go to previous selection
DOWN		To go to next selection
ENTER		To confirm the selection or go to next page

LED Indicator	Icon	Description
Battery		Charging the battery, the LED light flash. If battery is full, the LED light will always-on. The battery is not charged, the LED light will go out.
Utility		Inverter running in utility mode, the LED will always-on.
Inverter		Inverter running in off-grid mode, the LED light will flash. Inverter is not running in off-grid mode, the LED light will go out.
Fault		If inverter in fault event, the LED light will always-on. If inverter in warning event, the LED light will flash. Inverter work normally, the LED light will go out.
Buzzer Information		
Buzzer beep		Press any button, the buzzer will last for 0.1s. Hold on the "ENTER" button, the buzzer will last for 3s. If in fault event, the buzzer will keep going. If in warning event, the buzzer will beep discontinuous (Check more information on the chapter of "Warning Code Table").

LCD display Icons

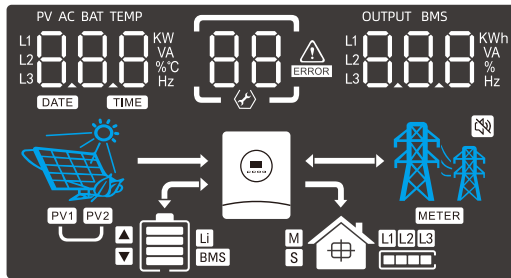

Icon	Function description
Input Source Information	
	Indicate input voltage, input frequency, PV voltage, PV power, battery voltage and charger current.
Configuration Program and Fault Information	
	Indicates the setting programs.
	Indicates the warning and fault codes. Warning: flashing with warning code. Fault: lighting with fault code.

Output Information	
	Indicate output voltage, output frequency, load percent, load in VA, load in Watt and discharging current.
Battery Information	
	Indicates battery level by 0-24%,25-49%,50-74% and 75-100%. The battery is connected normally, this icon is always on.
	If the inverter is in the process of lithium battery activation, or the battery is not connected, or the inverter is not connected to the grid and the battery voltage is low, this icon will flash.
	Indicates Lithium battery type.
	BMS Indicates communication is built between inverter and BMS. ▲ Indicates BMS allows battery discharge. ▼ Indicates BMS allows battery charge. Force charge occurs if icon flash.
Mode Operation Information	
	Indicates load is supplied by utility directly.
	Indicates the utility charger circuit is working.
	Indicates the inverter/charger is working.
	Indicates PV MPPT is working to power load.
	Indicates PV MPPT is working to charge battery.
	Indicates battery is discharging to load.
Mute Operation	
	Indicates unit alarm is disabled.

LCD operation flow chart

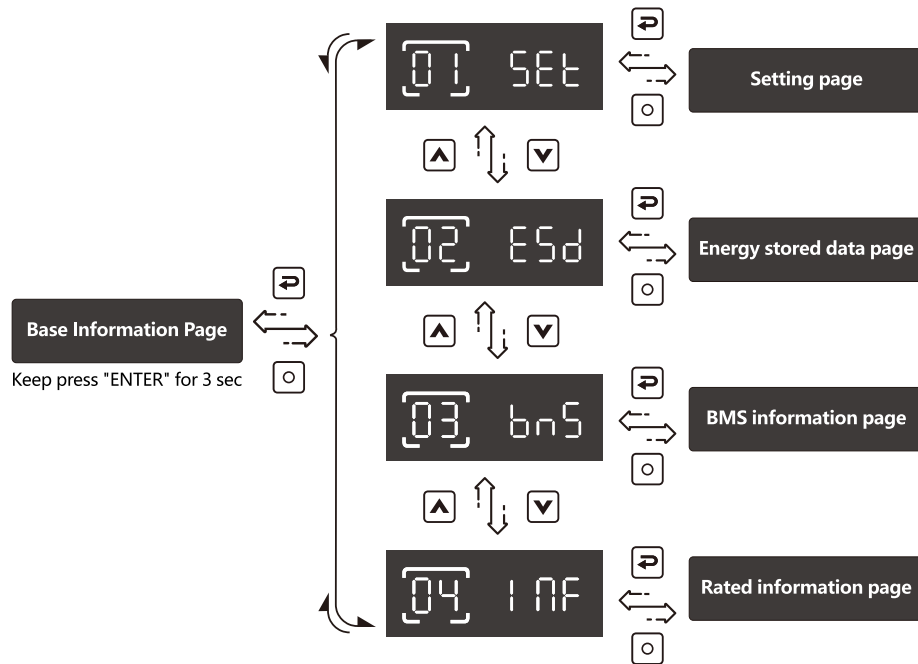

On base information page, pressing and holding "ENTER" key for 3 sec, the unit will enter parameters page. Press "UP" or "DOWN" key to switch the selection and press "ENTER" key to enter selected page. Press "ESC" key to back to previous page.

Base information Page

- The base information will be switched by pressing "UP" or "DOWN" key. The selectable information is switched as below order: (Take the 48V model for example).
- The 2nd AC output is enabled in program 64, the "L1" or "L2" icon on the LCD will be showed, only show "L1" represent to main AC output data, only show "L2" represent to 2nd AC output data. show "L1" and "L2" represent to all AC output data("L1" + "L2").

<p>Input voltage Output voltage Utility voltage is 230V, output voltage is 230V</p>	<p>Input frequency / Output voltage Utility frequency is 50.0Hz, output voltage is 230V</p>
--	--

<p>Generator voltage/Generator frequency Generator input voltage 230V, input frequency 50.0Hz</p>	<p>PV1 voltage / Output voltage PV1 voltage is 360V, output voltage is 230V</p>
<p>PV1 power / Output voltage PV1 power is 3.00kW, output voltage is 230V</p>	<p>PV2 voltage / Output voltage PV2 voltage is 360V, output voltage is 230V</p>
<p>PV2 power / Output voltage PV2 power is 3.00kW, output voltage is 230V</p>	<p>Battery voltage / Output voltage Battery voltage is 50.0V, output voltage is 230V</p>
<p>Charging current / Output voltage Charging current is 10A, output voltage is 230V</p>	<p>Battery voltage / Output frequency Battery voltage is 50.0V, output frequency is 50.0Hz</p>
<p>Battery voltage / Load percentage Battery voltage is 50.0V, load percentage is 40%</p>	<p>Battery voltage / L1 Load wattage Battery voltage is 51.9V, L1 output wattage is 6.16kW</p>

<p>Battery voltage / L2 Load wattage Battery voltage is 51.9V, L2 output wattage is 6.10kW</p>	<p>Battery voltage / Load VA Battery voltage is 50.0V, output wattage is 2.00kVA</p>
<p>Battery voltage / Load wattage Battery voltage is 50.0V, output wattage is 2.00kW</p>	<p>Battery voltage / Discharging current Battery voltage is 50.0V, discharging current is 80A</p>
<p>Battery voltage / SOC Battery voltage is 50.0V, SOC is 80%</p>	<p>Date 2023-06-01</p>
<p>Time 10:30:25</p>	

Note:











- Pages 6 and 7 of the basic information page are exclusive to **GPEO-12KL1**;
- " The small ICONS of the PV1 and PV2 are exclusive to the **GPEO-12KL1**;
- Pages 3 of the basic information page are unique to the **GPEO-12KL1**, and are only displayed when the generator input is enabled in the Settings item 64;
- Pages 12 and 13 of the basic page information are exclusive to **GPEO-12KL1**, and are only displayed when the second output is enabled in the 64th setting.
- Pages 17 of the basic page information is displayed only when the BMS communication is successful.













Setting Page

Press "UP" or "DOWN" button to select setting programs. And then, press "ENTER" button to confirm the selection or ESC button to exit.















Keep pressing UP or DOWN button after 1.5 seconds, it will increase or decrease setting value fastly.

Setting items:

		Selectable option		
00	Exit setting		ESC	
01	Battery type setting	AGM		Default AGM
		Flooded		FLD
		self-defined		USE
		Lib		LIB
				If "Self-defined" or "Lib" is selected, battery charge voltage and low DC cut-off voltage can be set up in program 03 , 04 and 05 . If "Lib" is selected, inverter can charge Lithium battery when the Lithium battery need to be activated. Please make sure Lithium battery is connected before you start up inverter. If inverter doesn't connect battery or Lithium battery, do not select "Lib" battery type.
02	BMS Type	bns		Default 1
		bns		0
				The default is the PYLONTECH protocol. If the battery type is customized or lithium battery, select the protocol based on the actual battery pack.
03	Bulk charging voltage setting (C.V voltage)	24V model		Default 28.2V
		48V model		Default 56.4V
				If "self-defined" or "Lib" is selected in program 01, this program is enabled. Setting range is from 24.0V to 30.0V. Note: If "AGM" in program 01, then "CV" is fixed at 28.2V and cannot be changed. If "FLD" in program 01, then "CV" is fixed at 29.2V and cannot be changed.
				If "self-defined" or "Lib" is selected in program 01, this program is enabled. Setting range is from 48.0V to 60.0V. Note: If "AGM" in program 01, then "CV" is fixed at 56.4V and cannot be changed. If "FLD" in program 01, then "CV" is fixed at 58.4V and cannot be changed.
04	Floating charging voltage	FLV		Default 27.0V
				If "self-defined" or "Lib" is selected in program 01, this program is enabled. Setting range is from 24.0V to 30.0V. Note: whether "AGM" or "FLD" in program 01, "FLV" is 27.0V and cannot be changed.













		48V model FLV 	Default 54.0V	If "self-defined" or "Lib" is selected in program 01, this program is enabled. Setting range is from 48.0V to 60.0V. Note: whether "AGM" or "FLD" in program 01, "FLV" is 54.0V and cannot be changed.
05	Low DC cut-off voltage or SOC (Note: If there is only battery, it will shut down.)	24V model bCV 	Default 21.0V	If "self-defined" is selected in program 01, this program is enabled. Setting range is from 21.0V to 26.0V.
		48V model bCV 	Default 42.0V	If "self-defined" is selected in program 01, this program is enabled. Setting range is from 42.0V to 52.0V.
		bCV 	Default 10%	If "Lib" is selected in program 01, the battery type is lithium battery, the set value will change to SOC. Setting range is from 0% to 95%.
06	Setting battery voltage or SOC point back to utility when selecting "SBU priority" in program 24	24V model bUV 	Default 23.0V	Setting range is from 22.0V to 27.0V. Increment of each click is 0.1V.
		48V model bUV 	Default 46.0V	Setting range is from 44.0V to 54.0V. Increment of each click is 0.1V.
		bUV 	Default 20%	If the battery type is lithium battery, the set value will change to SOC. Setting range is from 5% to 90%.
07	Setting battery voltage point back to battery mode when selecting "SBU priority" in program 24	24V model bbV 	Default 27.0V	Setting range is from 24.0V to 30.0V. Increment of each click is 0.1V.
		48V model bbV 	Default 54.0V	Setting range is from 48.0V to 60.0V. Increment of each click is 0.1V.
		Fully charged bbV 	FUL	Battery should be charged to float charging stage.
		bbV 	Default 70%	If the battery type is lithium battery, the set value will change to SOC. Setting range is from 10% to 100%.
09	Max charging current (Utility charge current +PV charging current)	60A bCC 	Default 60 ^A	Setting range is from 1A to 120A/120A/210A. Increment of each click is 1A.
10	Max utility charging current setting	30A cHC 	Default 30 ^A	Setting range is from 1A to 100A/120A/210A. Increment of each click is 1A.









Note: The setting value of item "07" should be larger than the setting value of item "06".

20	AC output mode	Single PAL 	Default SIG	When the units are used in parallel with single phase, please select "PAL" in program 20. It is required to have at least three inverters or maximum twelve inverters to support three-phase equipment. It's required to have at least one inverter in each phase or it's up to ten inverters for 6KW and six inverters for 12KW in one phase. Please select "3P1" in program 20 for the inverters connected to L1 phase, "3P2" in program 20 for the inverters connected to L2 phase and "3P3" in program 20 for the inverters connected to L3 phase. Before starting up inverters, please connect all N wires of AC output together. Note: GPEO-4KL1 can only be set to "SIG" Parallel Settings are not supported.
		Parallel PAL 	PAL	
		L1 Phase PAL 	3P1	
		L2 Phase PAL 	3P2	
		L3 Phase PAL 	3P3	
21	Output voltage setting	230V OPV 	Default 230V	Output voltage configuration.
		220V OPV 	220V	
		240V OPV 	240V	
22	Output frequency setting	50Hz OPF 	Default 50 ^{Hz}	Output frequency configuration.
		60Hz OPF 	60 ^{Hz}	
23	Utility input range setting	Appliance mode AC 	Default APL	APL should be selected, when the utility is not well.
		UPS mode AC 	UPS	
24	Output source priority	Utility >> PV >> Battery OP5 	Default US6	Utility provides power to the loads first. PV and battery will provide power to loads only when utility is not available.
		PV >> Utility >> Battery OP5 	SUB	PV provides power to the loads first. If PV is not sufficient, utility will supply power the loads at the same time. Battery will provide power to loads only when utility is not available.
		PV >> Battery >> Utility OP5 	SBU	PV provides power to the loads first. If PV is not sufficient, battery will supply power to the loads at the same time. Utility provides power to the loads only when battery voltage drops to the setting point in program 5.

25	Charger priority	If inverter is working in utility mode, charger priority can be set as below. However, when inverter is working in Battery mode, only PV can charge battery.		
		PV and Utility CHS 25 SNU	Default	PV and utility will charge battery together.
		PV First CHS 25 C50		PV will charge battery first. Utility will charge battery only when PV is unavailable.
		PV Only CHS 25 050		Only PV can charge the battery.
26	Feeding power to grid	Disable FPG 26 d15	Default	If selected, inverter is not allowed to feed exceeding solar power to grid.
		Enable FPG 26 ENA		If selected, inverter is allowed to feed exceeding solar power to grid.
27	Overload bypass function	Enable LBP 27 ENA	Default	If it is enabled, the inverter will switch to utility mode if overload happens in battery mode. If "SBU" is set in program 24, switch to mains bypass when the inverter is overloaded.
		Disable LBP 27 d15		
28	Overload restart function	Enable OLT 28 ENA	Default	If it is enabled, the inverter will auto restart when overload occurs.
		Disable OLT 28 d15		
29	Over temperature restart function	Enable OET 29 ENA	Default	If it is enabled, the inverter will auto restart when over temperature occurs.
		Disable OET 29 d15		
30	Power -Voltage curve	Disable PU 30 d15	Default	It is used to adjust the inverter active power according to the grid voltage. When the grid voltage exceeds 250V, the inverter begins to reduce active power.
		Enable PU 30 ENA		







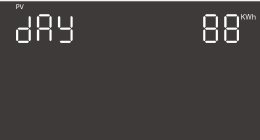

31	Zero Export Power	2EP 31 0	Default	Regulate the input power of the Grid while in SBU Mode. Setting range is from -90W to 90W. Increment of each click is 10W.
32	PEN Relay	For 12KVA model Disable PEN 32 d15	Default	If selected, The Ground wire is connected to the Neutral wire.
		For 12KVA model PEN 32 ENA	Enable	
40	Backlight of LCD	Enable bL 40 ENA	Default	If selected, LCD backlight will be always-on.
		Disable bL 40 d15		If selected, LCD backlight will be off after no button is pressed for 60s.
41	Auto return to the first page of display screen	Disable bFP 41 d15	Default	If selected, the display screen will stay at latest screen user finally switches.
		Enable bFP 41 ENA		If selected, it will automatically return to the first page of display screen (Input voltage / output voltage) after no button is pressed for 60s.
42	Buzzer Alarm	Enable bEP 42 ENA	Default	If selected, buzzer is allowed to beep.
		Disable bEP 42 d15		If selected, buzzer is not allowed to beep.
43	Energy stored data for PV and Load	Disable ESd 43 d15	Default	If selected, inverter will erase all historical data of PV and Load energy, and stop record historical data for PV and Load energy.
		Enable ESd 43 ENA		If selected, inverter will record historical data for PV and Load energy. Note: Before selected, please double check if date and time is correct, if incorrect, please set date and time in program 50~55.
44	Reset Default	Reset rSt 44 d15	Default	If selected, not reset.
		Reset rSt 44 ENA		If selected, Enable restores all settings other than the parallel output mode setting item (20) to their initial values. The inverter also erases all energy storage-related historical data.

45	Fan Work Mode	FAN  Default PFC	In performance mode, the inverter will perform at its highest performance.
		FAN  bLC	Balanced mode, applicable to the condition of 80% output power and 75% charge current limitation, to reduce additional noise greatly.
		FAN  sLC	Silent mode, applicable to the condition of 60% output power and 60% charge current limitation, to reduce additional noise extremely.
46	Failure recovery	Disable FFS  Default dIS	If selected, when the inverter enter the fault state, the inverter will not exit the fault state or start up again.
		Enable FFS  eNA	If selected, when the inverter enter the fault state, the inverter will exit the fault state and start up again.
50	Time setting-Year	Year YEA  23	Setting range is from 23 to 99.
51	Time setting-Month	Month n0N  8	Setting range is from 1 to 12.
52	Time setting-Day	Day dAY  20	Setting range is from 1 to 31.
53	Time setting-Hour	Hour HOU  21	Setting range is from 0 to 23.
54	Time setting-Minute	Minute n 1N  43	Setting range is from 0 to 59.
55	Time setting-Second	Second SEC  50	Setting range is from 0 to 59.
60	Low DC cut off voltage on second output	For 12KVA model bCS  Default 42.0 ^v	Setting range is from 42.0V to 48.0V. Increment of each click is 0.1V. This low DC cut-off voltage will be fixed to setting value no matter what percentage of load is connected.
		For 12KVA model bCS  Default 10%	If any type of lithium battery is selected in program 1, this parameter value will be displayed in percentage and value setting is based on battery capacity percentage. Setting range is from 0% to 95%. Increment of each click is 1%

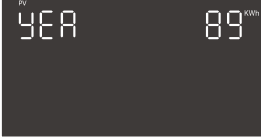
61	Setting discharge time on the 2nd output	For 12KVA model bds  Default dIS	Timing function disabled, the second output is allowed.
		For 12KVA model bds  5	Setting range is disable and then from 0 min to 990 min. Increment of each click is 1 min.
		For 12KVA model bds  Default 00F	*If the battery discharge time achieves the setting time in program 61 or the program 60 function is triggered, the second output will be turned off and the 61 programs will display OFF.
62	Scheduled time for 2nd AC output on	For 12KVA model bD0  Default 0	Setting range is from 00:00 to 23:00. Increment of each click is 1 hour. Within scheduled on/off time setting in program 62 and 63, 2nd AC output will be turn on/off based on the setting value in program 60 or 61.
63	Scheduled time for 2nd AC output off	For 12KVA model bDF  Default 0	
64	Smart port	For 12KVA model SPt  Default L0d	The port "(L2/GEN)-N" of AC output connector can be defined for "2nd AC output" or "Generator input". If "L0d" is selected, the 2nd AC output is enabled, the "L1" and "L2" icon on the LCD will be showed. If "GEN" is selected, the Generator input is enabled, the Grid icon on the LCD will flash every 5 seconds without AC input.
		For 12KVA model SPt  GEN	
65	Generator power limit	For 12KVA model GEN  Default 12 ^{kw}	Generator input power limit, set range from 1kW to 12kW, increase by 1kW per click. Note: 1. The set value must not exceed the generator's rated power to prevent device damage; 2. This function becomes ineffective when load power exceeds the set value (input power will match load demand); 3. The set value allocates power flexibly: e.g., if set higher than the load, surplus power will automatically charge the battery. 4. The maximum port current is 70A.

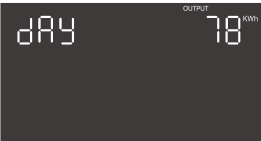





Energy stored data Page

The energy stored data will be switched by pressing "UP" or "DOWN" key. The selectable information is switched as below order:

<p>PV generated energy today 88 kWh</p> 	<p>PV generated energy this month 88 kWh</p> 	<p>PV generated energy this year 89 kWh</p> 
<p>PV generated energy current in total 348 kWh</p> 	<p>Load consumed energy today 78 kWh</p> 	<p>Load consumed energy this month 78 kWh</p> 
<p>Load consumed energy this year 80 kWh</p> 	<p>Load consumed energy in total 272 kWh</p> 	

BMS information Page

The BMS information will be switched by pressing "UP" or "DOWN" key. The selectable information is switched as below order: (Take the 48V model for example).





<p>Battery pack number / mean SOC Connected battery pack number is 4, mean SOC is 97%</p> 	<p>BMS voltage / SOC BMS voltage is 54.0V, SOC is 99% on battery pack of address 1</p> 	<p>BMS voltage / current BMS voltage is 54.0V, current is 1A on battery pack of address 1</p> 
<p>Charge voltage limit /charge current limit Charge voltage is 58.4V, charge current is 100A on battery pack of address 1</p> 	<p>Discharge voltage limit /discharge current limit Discharge voltage is 43.4V, discharge current is 100A on battery pack of address 1</p> 	<p>BMS highest temperature /lowest temperature BMS highest temperature is 25°C, lowest temperature is 20°C on battery pack of address 1</p> 

BMS fault code / flag
BMS fault code is 0, flag is 000 on battery pack of address 1

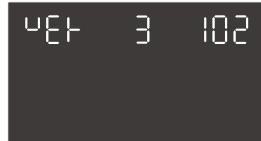

Rated information Page

The rated information will be switched by pressing "UP" or "DOWN" key. The selectable information is switched as below order: (Take the GPEO-12KL1 for example)

<p>Rated VA / WATT Rated VA is 12kVA, WATT is 12kW</p> 	<p>Rated battery voltage / Max. charge current Rated battery voltage is 48V, Max. charge current is 210A</p> 	<p>Firmware version (Master DSP) Firmware version is 3102</p> 
<p>Firmware version (Slave DSP) Firmware version is 3001</p> 		

Note:

- 1) The "3" on pages 3 and 4 represents the model. "1" is **GPEO-4KL1**; "2" is **GPEO-6KL1**; "3" is **GPEO-12KL1**.
- 2) Page 4 of the Rated information Page is exclusive to **GPEO-12KL1**.

Lithium Battery Communication

It is allowed to connect lithium battery and build communication only which it has been configured. Please follow below steps to configure communication between lithium battery and inverter.

1. Connect power cable between lithium battery and inverter. Please pay attention to the terminals of positive and negative. Make sure the positive terminal of battery is connected to the positive terminal of inverter, and the negative terminal of battery is connected to the negative terminal of inverter.
2. The communication cable is bundled with lithium battery. Both sides are RJ45 port. One port is connected to the BMS port of inverter and another one is connected to the COMM port of lithium battery.

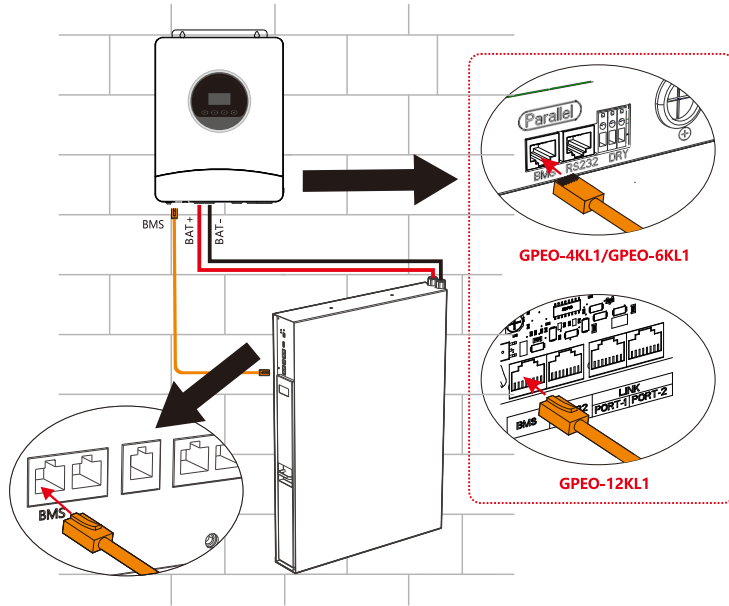

3. Configure battery type to "Lib" in LCD setting No.01.

The battery type is Lib

BAT 01 Lib

And then LCD will show you "Li" icon.

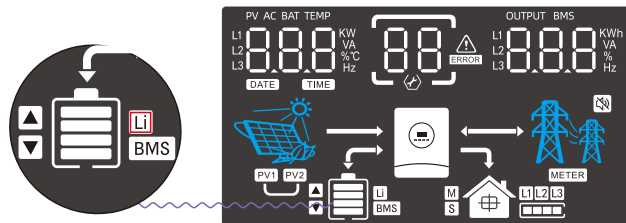

4. Power up lithium battery and inverter. Wait a moment, if the communication is built between them, LCD will show you "BMS" icon as below.

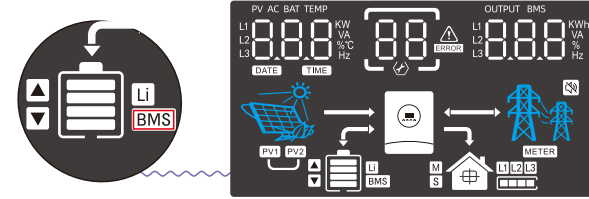

5. Roll LCD real time information pages by pressing "UP" or "DOWN" button, as below page, you can see the parameters of SOC in the communication system.

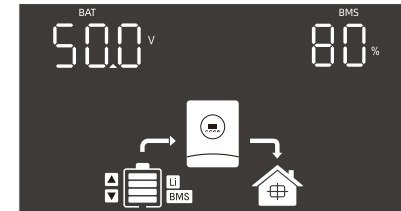

This page means SOC is 80%.

PARALLEL INSTALLATION GUIDE (Not Valid for 4KVA Model)

Introduction

This inverter can be used in parallel with two different operation modes.

1. Parallel operation in single phase with up to 12 units for **GPE0-6KL1**, the supported maximum output power is 72kW/72kVA. Parallel operation in single phase with up to 6 units for **GPE0-12KL1**, the supported maximum output power is 72kW/72kVA.
2. Maximum twelve units work together to support three-phase equipment. The supported maximum output power is 72kW/72kVA and one phase can be up to 60kW/60kVA for **GPE0-6KL1**; The supported maximum output power is 144kW/144kVA and one phase can be up to 72kW/72kVA for **GPE0-12KL1**.

NOTE 1: If this unit is bundled with parallel cable, this inverter is default supported parallel operation. You may skip section 2.

NOTE 2: Under parallel operation modes, battery must be connected with inverters.

NOTE 3: Before starting up inverters, please connect all negative(-) wires of battery together for **GPE0-6KL1**.

NOTE 4: Before starting up inverters, all batteries of the inverters must parallel together for **GPE0-12KL1**.

Mounting the Unit

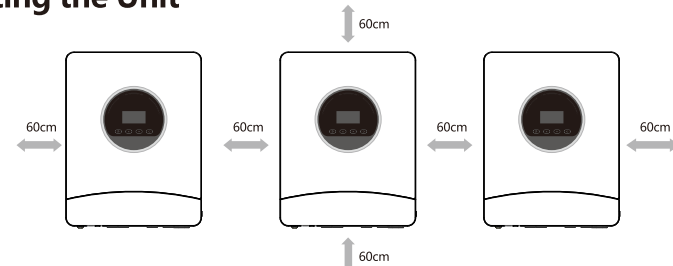

Note: For proper air circulation to dissipate heat, allow a clearance of approx. 60cm to the side and approx. 60cm above and below the unit. Be sure to install each unit in the same level.

Package Contents

In parallel kit, you will find the following items in the package.



Parallel communication cable x 1 pcs



Parallel communication terminal connector x1 pcs

Wiring Connection

This installation steps are only applied to GPEO-6KL1/GPEO-12KL1 model.

N Inverters Communication Connection

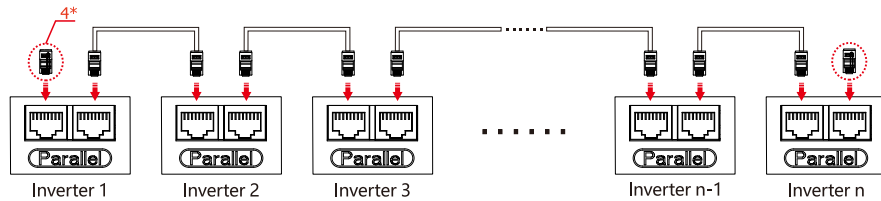
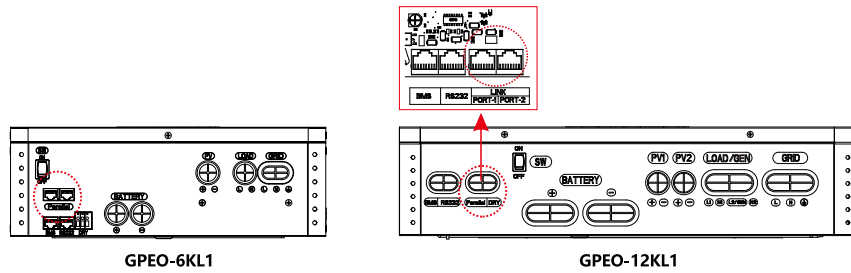

Connect parallel communication cable one by one.

4*: Connect parallel communication connector to the first one and the last one.

Single Phase Parallel connection diagram for two inverters in parallel for GPEO-6KL1.

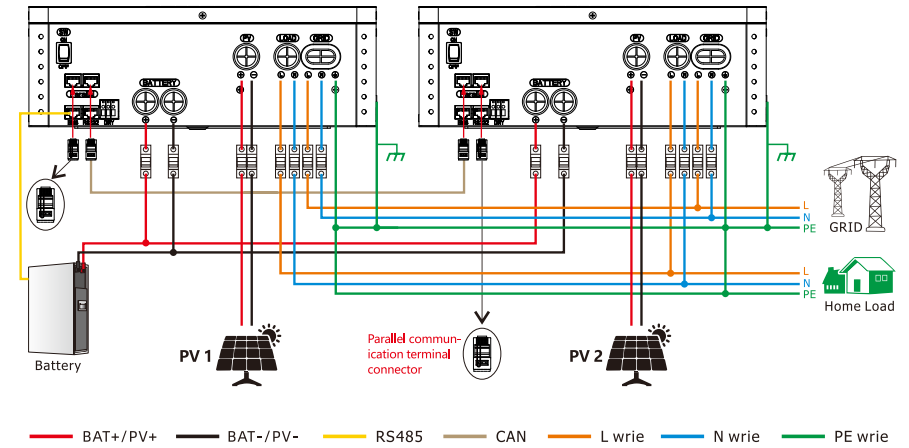

WARNING!! Strictly maintain insulation between PV ports in parallel systems. A single PV module's L/N lines MUST NOT be connected to PV ports of two or more inverters in the parallel configuration.

Note: Before starting up inverters, please connect all positive (+) and negative (-) wires of battery together.

Single Phase Parallel connection diagram for two inverters in parallel for GPEO-12KL1.

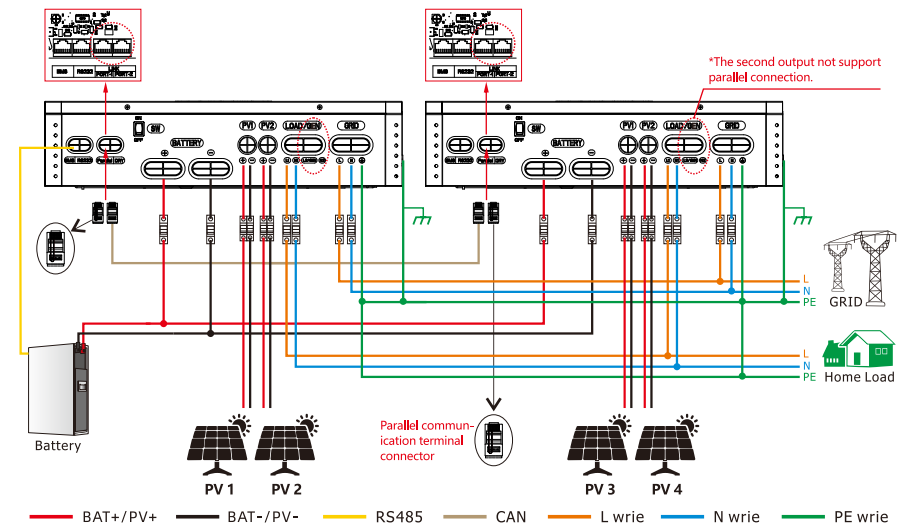

WARNING!! Strictly maintain insulation between PV ports in parallel systems. A single PV module's L/N lines MUST NOT be connected to PV ports of two or more inverters in the parallel configuration.

Note: Before starting up inverters, please connect all positive (+) and negative (-) wires of battery together.

Single Phase Parallel connection diagram for three to twelve inverters in parallel for GPEO-6KL1.

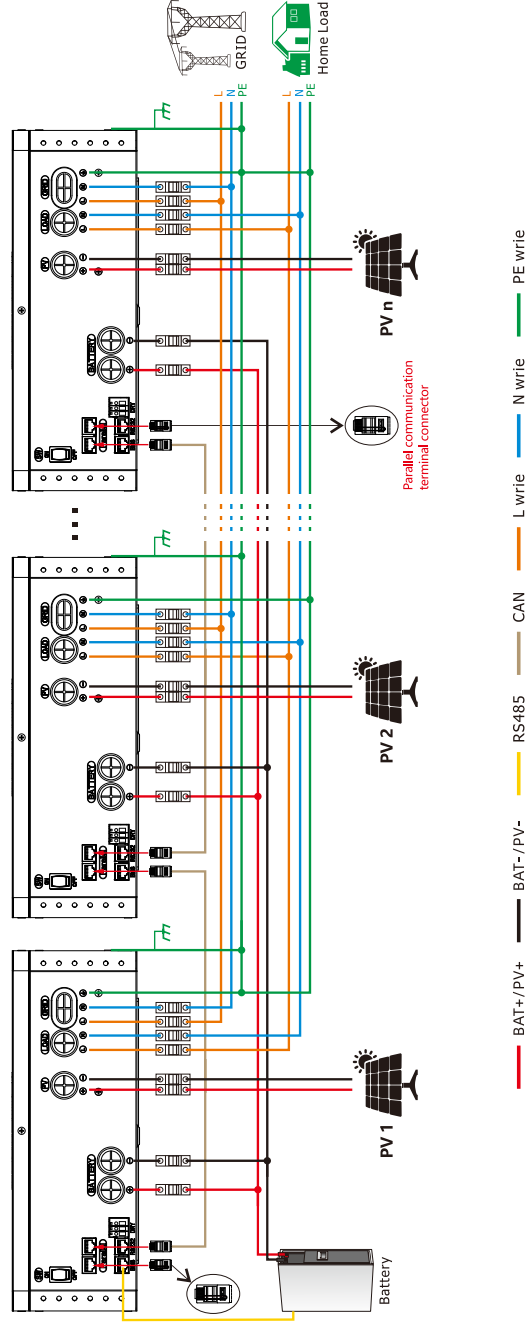

⚠ WARNING! Strictly maintain insulation between PV ports in parallel systems. A single PV module's L/N lines **MUST NOT** be connected to PV ports of two or more inverters in the parallel configuration.

Note:

1. "n" is the number of parallel connections of the inverters.
2. Before starting up inverters, please connect all positive (+) and negative (-) wires of battery together.

Single Phase Parallel connection diagram for three to twelve inverters in parallel for GPEO-12KL1.

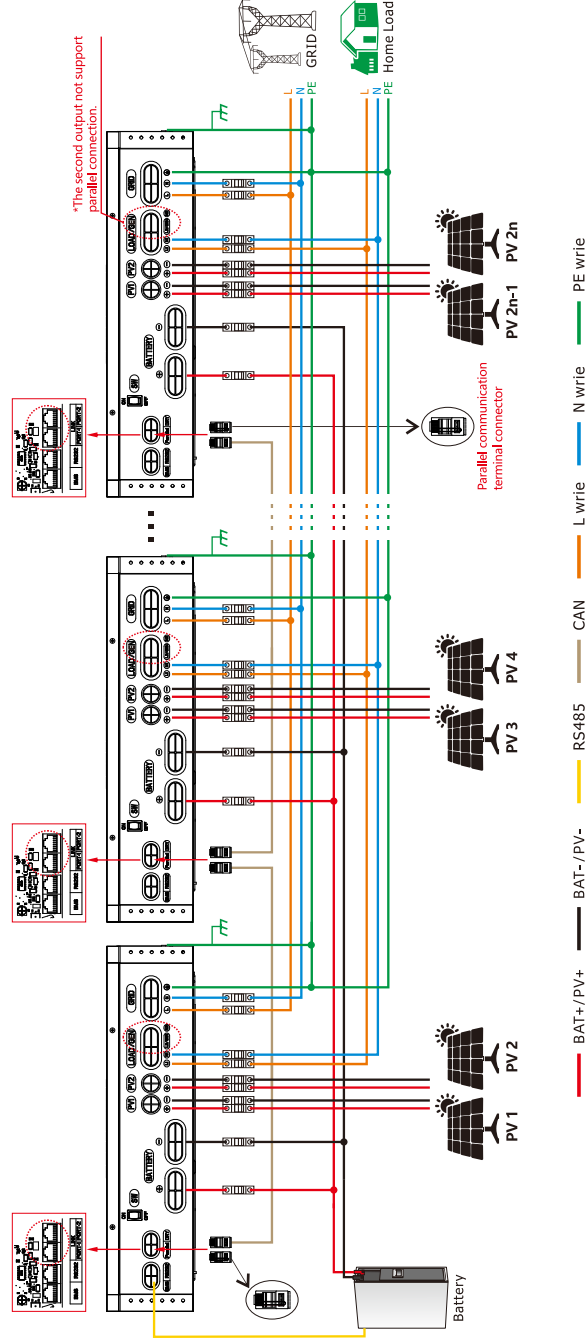

⚠ WARNING! Strictly maintain insulation between PV ports in parallel systems. A single PV module's L/N lines **MUST NOT** be connected to PV ports of two or more inverters in the parallel configuration.

Note:

1. "n" is the number of parallel connections of the inverters.
2. Before starting up inverters, please connect all positive (+) and negative (-) wires of battery together.

Three Phase Parallel connection diagram for three inverters in parallel for GPEO-6KL1.

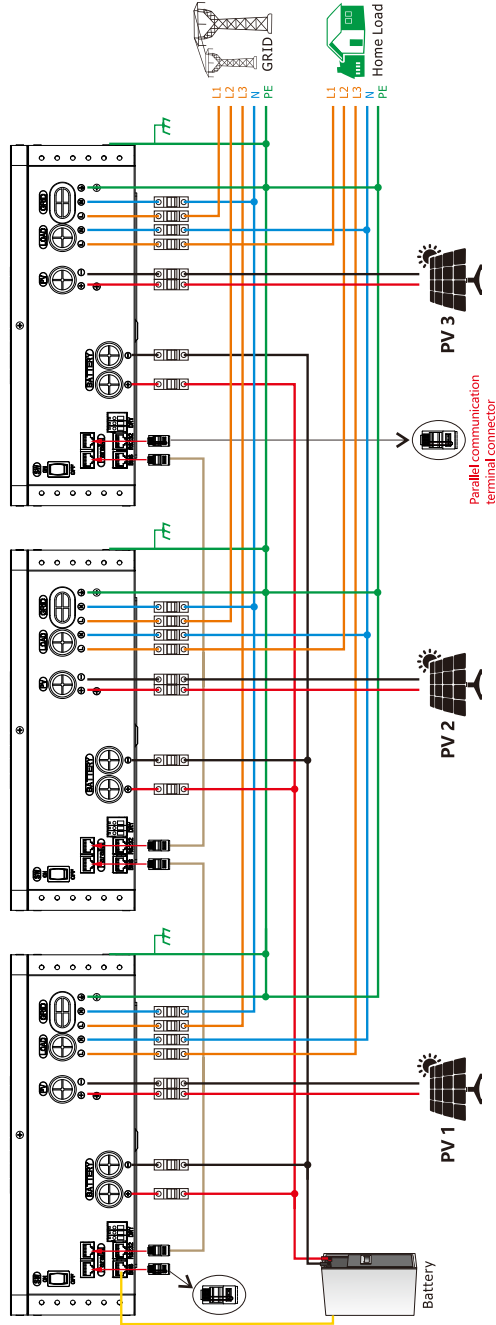

— BAT+/PV+ — BAT-/PV- — RS485 — CAN — L wire — N wire — PE wire

⚠ WARNING! Strictly maintain insulation between PV ports in parallel systems. A single PV module's L/N lines **MUST NOT** be connected to PV ports of two or more inverters in the parallel configuration.

Note: Before starting up inverters, please connect all positive (+) and negative (-) wires of battery together.

Three Phase Parallel connection diagram for three inverters in parallel for GPEO-12KL1.

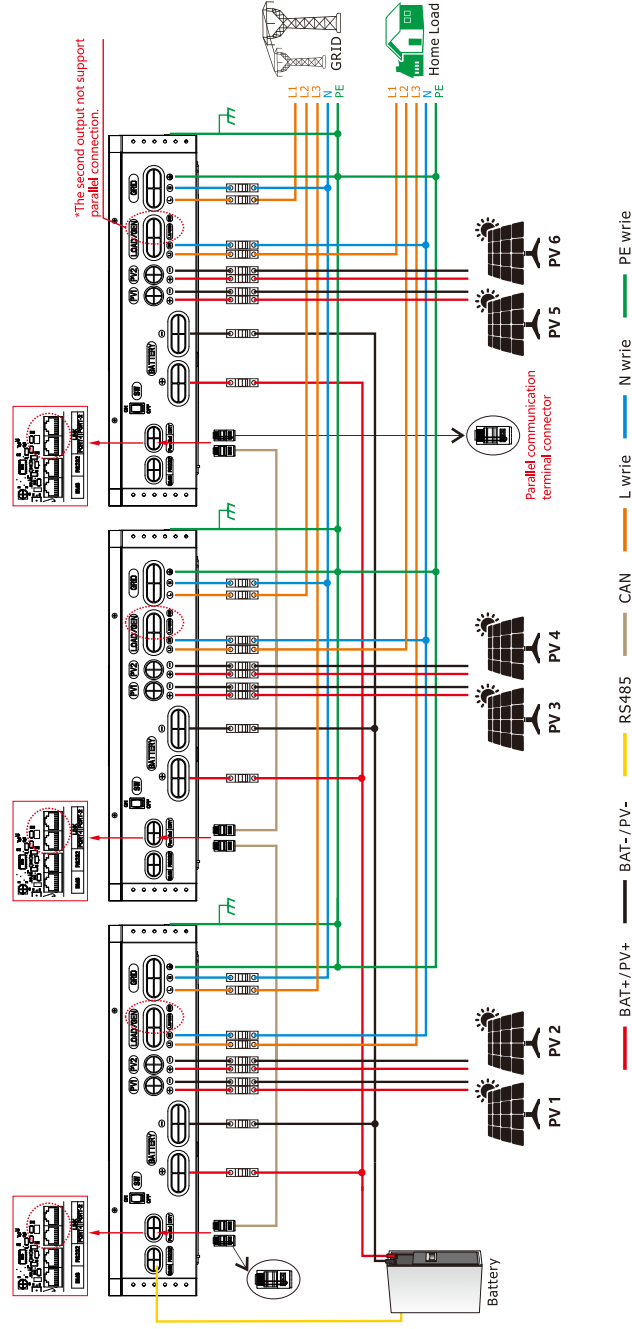

— BAT+/PV+ — BAT-/PV- — RS485 — CAN — L wire — N wire — PE wire

⚠ WARNING! Strictly maintain insulation between PV ports in parallel systems. A single PV module's L/N lines **MUST NOT** be connected to PV ports of two or more inverters in the parallel configuration.

Note: Before starting up inverters, please connect all positive (+) and negative (-) wires of battery together.

Three Phase Parallel connection diagram for four to twelve inverters in parallel for GPEO-6KL1.

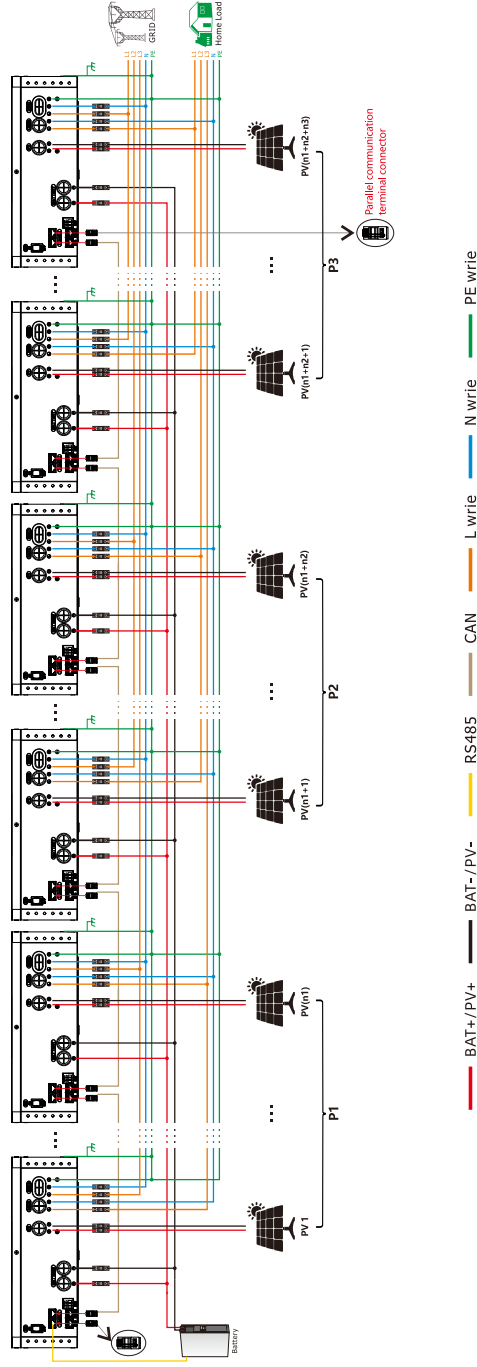

WARNING! Strictly maintain insulation between PV ports in parallel systems. A single PV module's L/N lines **MUST NOT** be connected to PV ports of two or more inverters in the parallel configuration.

Note:

1. "n1" / "n2" / "n3" is the number of parallel units for P1/P2/P3 phase.
2. Before starting up inverters, please connect all positive (+) and negative (-) wires of battery together.
3. 6KVA each inverter must be connected to a separate photovoltaic; 12KVA each inverter must be connected to two separate photovoltaics.
4. Each phase is connected with at least one, a maximum of 6 parallel units for same phase; and a maximum of 12 parallel units for three phases.

Three Phase Parallel connection diagram for four to twelve inverters in parallel for GPEO-12KL1.

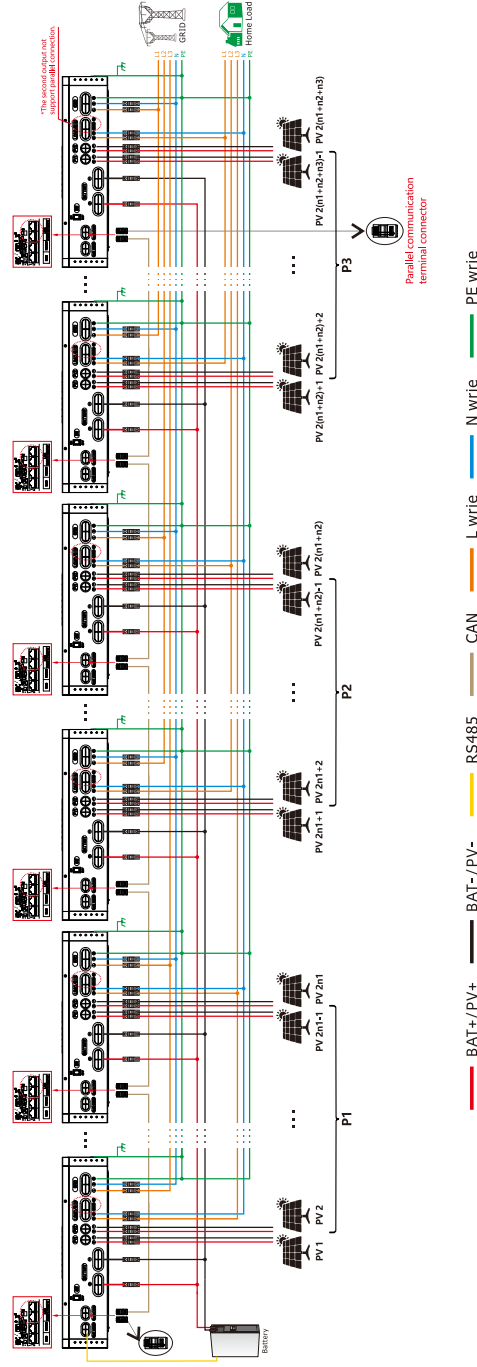

WARNING! Strictly maintain insulation between PV ports in parallel systems. A single PV module's L/N lines **MUST NOT** be connected to PV ports of two or more inverters in the parallel configuration.

Note:

1. "n1" / "n2" / "n3" is the number of parallel units for P1/P2/P3 phase.
2. Before starting up inverters, please connect all positive (+) and negative (-) wires of battery together.
3. 6KVA each inverter must be connected to a separate photovoltaic; 12KVA each inverter must be connected to two separate photovoltaics.
4. Each phase is connected with at least one, a maximum of 6 parallel units for same phase; and a maximum of 12 parallel units for three phases.

LCD Setting and Display

Setting Program

20	AC output mode	Single SIG	When the units are used in parallel with single phase, please select "PAL" in program 20. It is required to have at least three inverters or maximum twelve inverters to support three-phase equipment. It's required to have at least one inverter in each phase or it's up to ten inverters in one phase. Please select "3P1" in program 20 for the inverters connected to L1 phase, "3P2" in program 20 for the inverters connected to L2 phase and "3P3" in program 20 for the inverters connected to L3 phase. Before starting up inverters, please connect all N wires of AC output together. Note: GPEO-4KL1 can only be set to "SIG". Parallel Settings are not supported.
		Parallel PAL	
		L1 Phase 3P1	
		L2 Phase 3P2	
		L3 Phase 3P3	

Commissioning

Parallel in single phase

Step 1: Check the following requirements before commissioning:

- Correct wire connection.
- Ensure all breakers in Line wires of load side are open and each Neutral wires of each unit are connected together.

Step 2: Turn on each unit and set "PAL" in LCD setting program 20 of each unit. And then shut down all units.

NOTE: To be safe, it's better to turn off switch when setting LCD program.

Step 3: Turn on each unit.

LCD display in Master unit	LCD display in Slave unit

Note: Master and slave units are randomly defined.

Step 4: Switch on all AC breakers of Line wires in AC input. It's better to have all inverters connect to utility at the same time. However, these inverters will automatically restart. If detecting AC connection, they will work normally.

LCD display in Master unit	LCD display in Slave unit

Step 5: If there is no more fault alarm, the parallel system is completely installed.

Step 6: Please switch on all breakers of Line wires in load side. This system will start to provide power to the load.

Support three-phase equipment

Step 1: Check the following requirements before commissioning:

- Correct wire connection.
- Ensure all breakers in Line wires of load side are open and each Neutral wires of each unit are connected together.

Step 2: Turn on all units and configure LCD program 20 as P1, P2 and P3 sequentially. And then shut down all units.

Note: To be safe, it's better to turn off switch when setting LCD program.

Step 3: Turn on all units sequentially.

LCD display in L1-phase unit	LCD display in L2-phase unit	LCD display in L3-phase unit

Step 4: Switch on all AC breakers of Line wires in AC input. If AC connection is detected and three phases are matched with unit setting, they will work normally. Otherwise, the AC icon will flash and they will not work in line mode.

LCD display in L1-phase unit	LCD display in L2-phase unit	LCD display in L3-phase unit

Step 5: If there is no more fault alarm, the system to support 3-phase equipment is completely installed.

Step 6: Please switch on all breakers of Line wires in load side. This system will start to provide power to the load.

Note 1: To avoid overload occurring, before turning on breakers in load side, it's better to have whole system in operation first.

Note 2: Transfer time for this operation exists. Power interruption may happen to critical devices, which cannot bear transfer time.

WARNING CODE TABLE

When fault event happens, the fault LED is flashing. At the same time, warning code, icon  is shown on the LCD screen.

Warning Code	Warning Information	Audible Alarm	Trouble shooting
01	Overload	Beep twice every second	Reduce the loads.
02	Fan is locked (up)	Beep three times every second	Check if the Fans wiring connected well. Replace the fan.
03	Fan is locked (down)	Beep three time every second	Check if the Fans wiring connected well. Replace the fan.
04	Grid over voltage warning	No buzzer alarm	Check whether the grid voltage exceeds the allowable range of the inverter.
05	Output not connected together in parallel mode	No buzzer alarm	Check whether the output load of the inverter is normal, and check whether the inverters are connected together in the same phase.
06	Remote shutdown warning	No buzzer alarm	Check if remote shutdown is enabled via WIFI. Disable the enable or restart the inverter.
07	Second output overload	No buzzer alarm	Reduce the connected load by switching off some equipment, and restart the unit, if the error happens again, please return to repair center.
10	Parallel grid lost	No buzzer alarm	Check whether the mains input cable of the inverter is abnormal, and restart the unit, if the error happens again, please return to repair center.
11	Abnormal battery voltage	No buzzer alarm	Check whether the battery has any abnormal faults or if the battery power is insufficient to support the current load. If the battery power is insufficient, please reduce the load usage. If there is any abnormality with the battery, please contact the repair center to troubleshoot the issue.

FAULT CODE TABLE

When fault event happens, inverter will cut off output, and the fault LED is solid on. At the same time, fault code, icon  and **ERROR** are shown on the LCD screen.

Fault Code	Fault information	Trouble Shooting
01	Bus voltage is too high	AC Surge or internal components failed. Restart the unit, if the error happens again, please return to repair center.
02	Bus voltage is too low	Restart the unit, if the error happens again, please return to repair center.
03	Bus soft start fail	Internal components failed. Restart the unit, if the error happens again, please return to repair center.
10	Inverter soft start fail	Internal components failed. Restart the unit, if the error happens again, please return to repair center.

11	Over current or surge detected by Software	Restart the unit, if the error happens again, please return to repair center.
12	Over current or surge detected by hardware	Restart the unit, if the error happens again, please return to repair center.
13	Output voltage is too low	Reduce the connected load. Restart the unit, if the error happens again, please return to repair center.
14	Output voltage is too high	Restart the unit, if the error happens again, please return to repair center.
15	Output short circuited	Check if wiring is connected well and remove abnormal load.
16	Inverter current sensor failed	Restart the unit, if the error happens again, please return to repair center.
17	Current feedback into the inverter is detected.	1. Restart the inverter. 2. Check if L/N cables are not connected reversely in all inverters. 3. For parallel system in single phase, make sure the sharing cables are connected in all inverters. For supporting three-phase system, make sure the sharing cables are connected in the inverters in the same phase, and disconnected in the inverters in different phases. 4. If the problem remains, please contact your installer.
20	Overload time out	Reduce the connected load by switching off some equipment.
21	OP current sensor failed	Restart the unit, if the error happens again, please return to repair center.
22	Sharing current sensor failed	Restart the unit, if the error happens again, please return to repair center.
23	The AC input and output wires are inversely connected	1. Please check AC input and output wires are connected correctly. 2. If this error happens during parallel installation, please check wires connection. If they are connected correctly, please finish parallel installation first, and then restart inverters. 3. If the problem remains, please contact your installer.
24	The output relay exception	Restart the unit, if the error happens again, please return to repair center.
30	Battery voltage is too high	Check if spec and quantity of batteries are meet requirements.
31	Over current happen at DC/DC circuit	Restart the unit, if the error happens again, please return to repair center.
32	DC/DC current sensor failed	Restart the unit, if the error happens again, please return to repair center.
33	No.2 DCDC current sensor failed	Restart the unit, if the error happens again, please return to repair center.
34	DC/DC soft start fail	Restart the unit, if the error happens again, please return to repair center.
35	Over current happen at DC/DC circuit detected by hardware	Restart the unit, if the error happens again, please return to repair center.
36	Over current happen at LLC circuit	Restart the unit, if the error happens again, please return to repair center.

37	LLC hardware fault	Restart the unit, if the error happens again, please return to repair center.
40	PV voltage is too high	Reduce the number of PV modules in series.
41	Short circuited happen at PV port	Check if wiring is connected well.
42	PV power abnormally	Restart the unit, if the error happens again, please return to repair center.
43	Over current happen at PV port	Restart the unit, if the error happens again, please return to repair center.
44	PV current sensor failed	Restart the unit, if the error happens again, please return to repair center.
45	PV1 high input power	Reduce the connected load. Restart the unit, if the error happens again, please return to repair center.
46	PV2 high input power	Reduce the connected load. Restart the unit, if the error happens again, please return to repair center.
50	Fan is locked	Check if wiring is connected well. Replace the fan.
51	Over temperature happen at PV circuit	The temperature of internal PV component is over the limitation. Check whether the air flow of the unit is blocked or whether the ambient temperature is too high.
52	Over temperature happen at INV circuit	The temperature of internal INV component is over the limitation. Check whether the air flow of the unit is blocked or whether the ambient temperature is too high.
53	Over temperature happen at Convert L circuit	The temperature of Convert L battery converter component is over the limitation. Check whether the air flow of the unit is blocked or whether the ambient temperature is too high.
54	Over temperature happen at Convert H circuit	The temperature of internal Convert H component is over the limitation. Check whether the air flow of the unit is blocked or whether the ambient temperature is too high.
55	Over temperature happen at LLC TX	The temperature of internal DC/DC TX is over the limitation. Check whether the air flow of the unit is blocked or whether the ambient temperature is too high.
60	CAN data loss	1. Check if communication cables are connected well and restart the inverter. 2. If the problem remains, please contact your installer.
61	Host data loss	
62	Synchronization data loss	
63	The firmware version of each inverter is not the same	1. Update all inverter firmware to the same version. 2. Check the version of each inverter via LCD setting and make sure the CPU versions are same. If not, please contact your installer to provide the firmware to update. 3. After updating, if the problem still remains, please contact your installer.
64	The output current of each inverter is different	1. Check if sharing cables are connected well and restart the inverter. 2. If the problem remains, please contact your installer.

65	AC output mode setting is different	1. Switch off the inverter and check LCD setting program 20. 2. For parallel system in single phase, make sure no 3P1, 3P2 or 3P3 is set on program 20. For supporting three-phase system, make sure no "PAL" is set on program 20. 3. If the problem remains, please contact your installer.
66	Single unit is installed to parallel system	1. Please check if single unit is installed to parallel system. 2. If this error happens during parallel installation, please check wires connection. If they are connected correctly, please finish parallel installation first, and then restart inverters. 3. If the problem remains, please contact your installer.
92	DSP failed to communicate with MCU	Restart the unit, if the error happens again, please return to repair center.